

E-Z COMMAND

DYNAMIS®

Wireless DCC Digital Control System



CAUTION-ELECTRICALLY OPERATED PRODUCT

NOT RECOMMENDED FOR CHILDREN UNDER 8 YEARS OF AGE. AS WITH ALL ELECTRIC PRODUCTS, PRECAUTIONS SHOULD BE OBSERVED DURING HANDLING AND USE TO PREVENT ELECTRIC SHOCK. INPUT: 100 - 240 VAC 50/60Hz. OUTPUT: DC 16V 2300mA

Bachmann E-Z Command Dynamis User Guide

Contents

Introduction	3
Hardware overview	4
Handset	4
Command station	5
Handset screen overview	6
Action key icons	7
Getting Started	8
How to use the joystick	9
How to configure the locomotive roster	9
How to manage consists	13
How to operate turnouts and accessories	15
How to program locomotive decoder CVs	16
How to configure using the System menu	17
How to make the best of Dynamis on your layout	19
Safety and care of your Dynamis	21
Fault finding	22
Other Bachmann E-Z Command® DCC products	23
Warranty information	23
Technical support	23
Dynamis Menu Reference	24

Introduction

Thank you for your choice of the Bachmann E-Z Command® Dynamis® DCC model train control system. You have chosen an easy to use yet highly sophisticated product. Please take a few moments to become familiar with the product by reading this manual before proceeding. Using the Dynamis DCC system is simple as all actions are guided by the screen icons with four Action Keys beneath.

The Dynamis DCC system features a powerful bi-directional infrared hands-free control unit for convenient operation around your layout. Information passes both ways between Command Station and Handset to ensure communication integrity. Both units have been designed to have a wide transmission and reception arc for optimal performance.

Dynamis can be used with model trains of any scale: power hungry Large Scale trains may require the use of the E-Z Command® 5-amp booster.

This Dynamis starter system contains:

- Wireless handset
- Command Station with receiver
- Lanyard
- Track lead
- AAA / MN2400 /LR03 batteries (4) for handset
- Mains transformer

IMPORTANT

Bachmann E-Z Command® Dynamis® runs NMRA DCC decoder fitted trains only: it does not run a train without a decoder. Damage may result to any train without a decoder placed on a track powered by Dynamis.

Dynamis is a DCC system which is compliant with the NMRA DCC standards



Hardware overview

The Handset

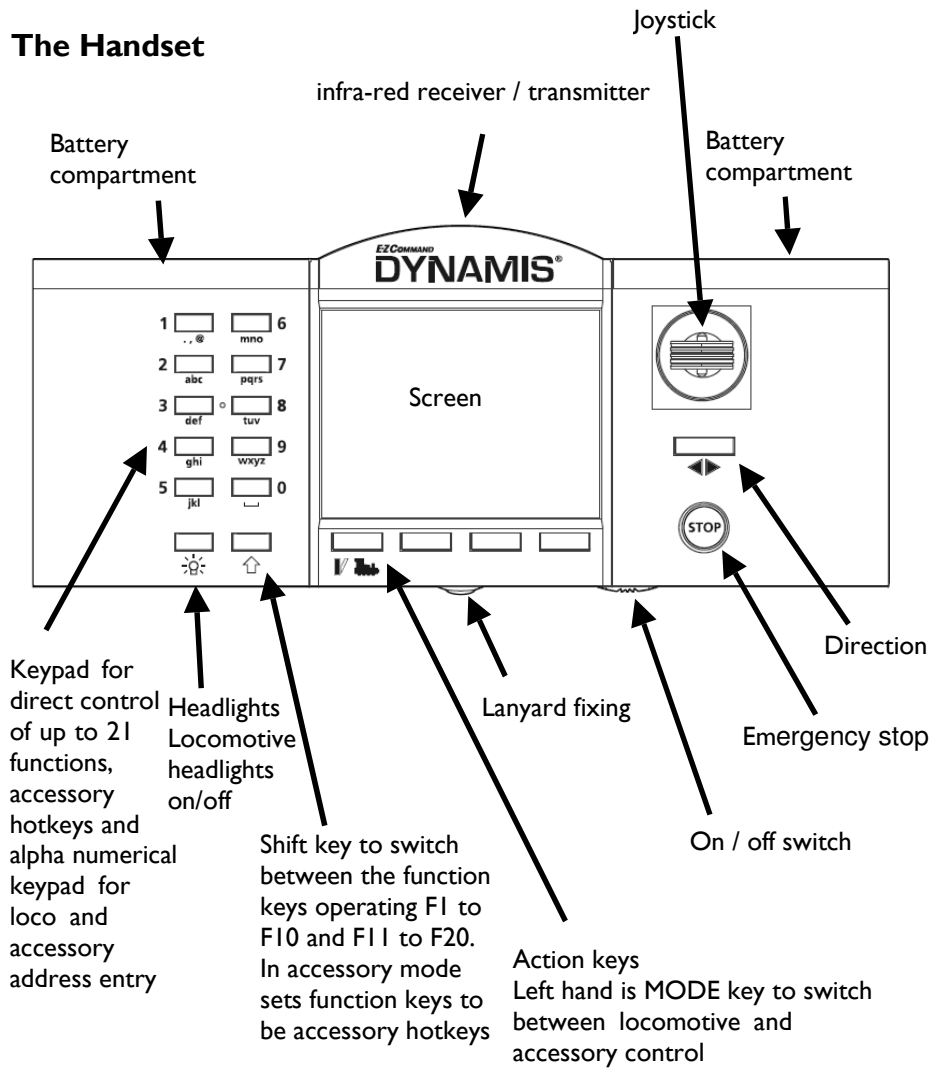

The Command Station

Receiver connection

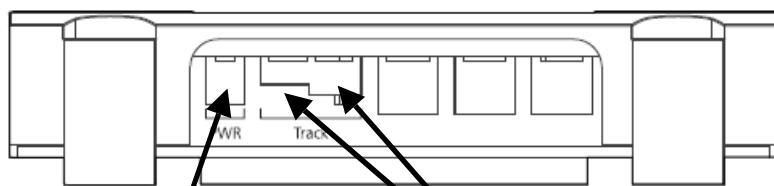
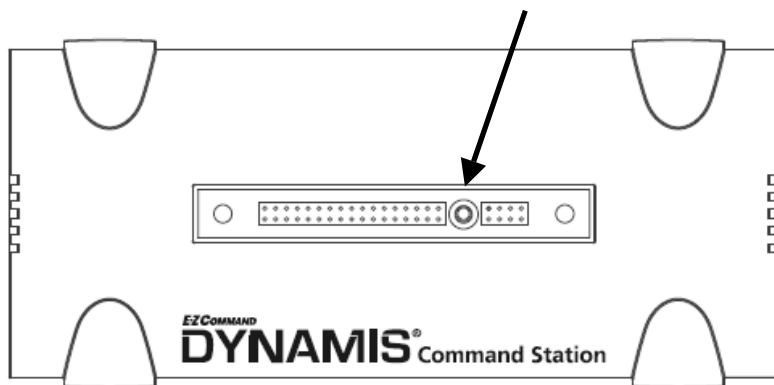

DC power pack connector
Use only the supplied wall
transformer

Output connectors,
3.5mm jack or plug with screw
terminal

Receiver LEDs

There are indicator LEDs located within the receiver

NORMAL OPERATIONS

Left hand - constant indicating power to Command Station
Right hand - flashes on receipt of Handset signals

STOP pressed / short circuit on track

Left hand flashes

HANDSET OUT OF RANGE OF COMMAND STATION

Left hand and Right hand both flash rapidly







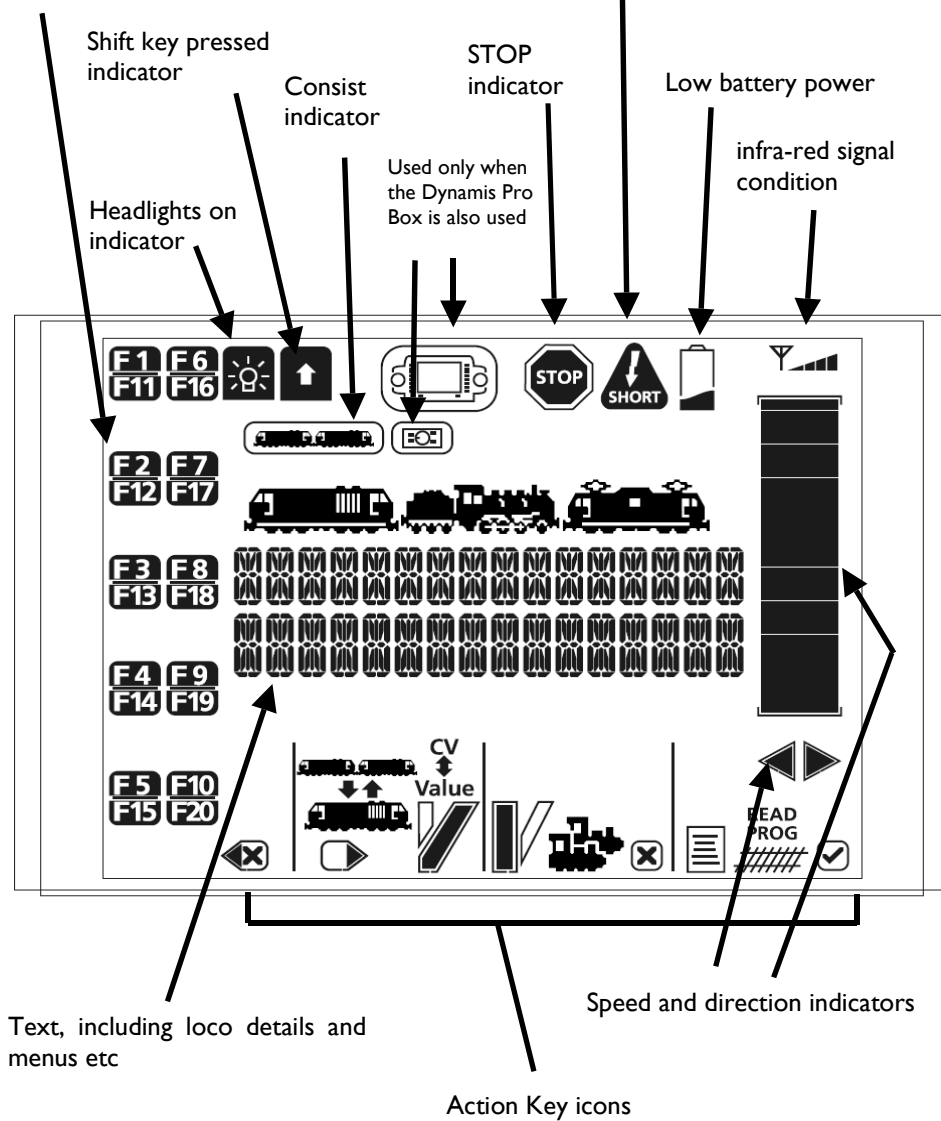

Handset screen overview

Indicators for decoder function status on/off

Track short circuit reported by Command station



Action key icons

Icon	Key purpose when icon shown	Referred to as
	Add loco to / remove from Consist	[CONSIST]
	Select locomotive by address	[LOCO]
	Turnout / accessory operation - turnouts left / right or accessories on / off	[DIVERGE] or [STRAIGHT]
	Access the menu	[MENU]
	Accept Cancel	[ACCEPT] [CANCEL]
	Scroll left or right	[SCROLL]
	Move between CV selection and value for CV in the programming menus	[CV<>] [<>VALUE]
	Write value to CV / read from CV (reading CV values requires Dynamis ProBox)	[READ] [PROG]
	Backspace in text entry	[BKSP]

Getting Started

1. Attach lanyard to the handset. To avoid dropping the unit use the lanyard around neck or wrist.

2. Insert 4 AAA batteries into handset orientating as shown on the diagram. The battery covers are removed by carefully releasing the clips at the rear of the handset

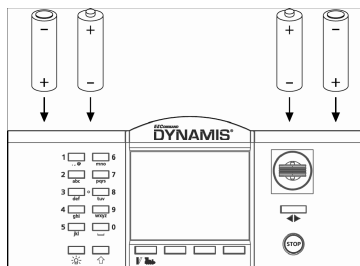

3. Connect receiver to terminal on top of the Command Station.

4. Place Command Station by layout, locating in a position with a good angle of view to the Command Station infra-red receiver. Remove existing controllers / power packs and connect the wires to the Command Station.

Use the red lead with jack plug to connect to Bachmann E-Z Track® or the Bachmann Branchline track powerclip

Other leads with bare wire connectors can be connected to the green connector block which plugs to the Command Station. This is recommended for layouts using higher track power.

Please refer to '**How to make the best of Dynamis on your layout**' section for advice on connecting to existing layouts

5. Select the appropriate mains pins for the wall transformer: they fit and lock in place with a twist action. **THIS PROCEDURE SHOULD BE CARRIED OUT BY AN ADULT**

6. Connect the power supply lead to the Command Station. Plug the transformer into wall socket. The LED on the Command station receiver will be illuminated.

7. Turn on the Handset with the switch underneath – the Handset always powers up with the STOP cutout in place (press STOP button to proceed) and ready to run a locomotive with address 3.

8. Place a locomotive on the track. New DCC locomotives or decoders are shipped with an address of 3.

To run a locomotive with a different address, press [LOCO] key and then enter locomotive address and press [ACCEPT]. This locomotive number shows on the screen along with a default roster entry that has been created.

How to use the joystick

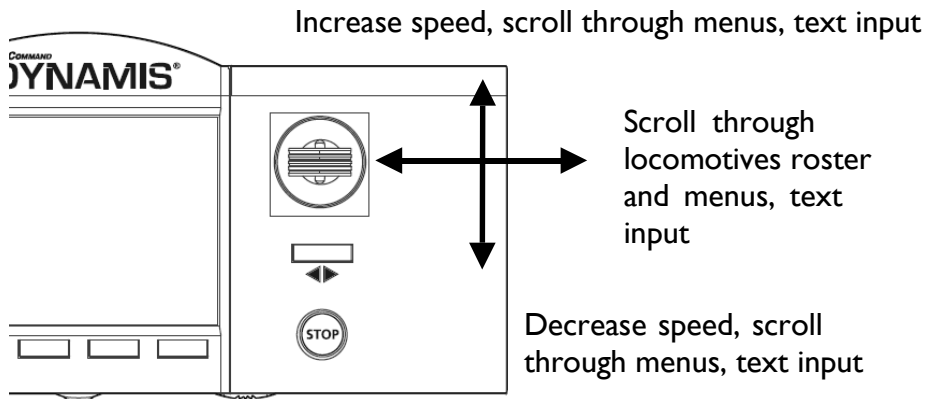

9. Push the joystick upwards to move the locomotive, bring it downwards to bring the locomotive to a stop. Change direction by pressing the direction button beneath the joystick.

10. Leaving the first train running, select a second locomotive address using the joystick or the [LOCO] key. Set the train running. Move back to the first train by scrolling with the Joystick. When selecting another moving train the bar graph for speed immediately shows current speed of that train so that any change to speed is made from the speed at which it is currently travelling.

How to configure the locomotive roster

There is a 40 locomotive roster database recording details of the locos. When first selecting a locomotive address to run a roster entry is created with default values. Once there are 40 roster entries one must be deleted to allow any other locomotives to be run.

EXAMPLE: Changing the address and defaults of locomotive

A short (up to 127) or long addresses ("4-digit") can be written to a decoder by programming using a Service Track with no other locomotives present otherwise all locomotives will adopt the address. If necessary create a separate length of track powered by your Dynamis for this purposes. Additionally, a short address can be changed to another short address using Main Track / "Ops mode" programming if

the decoder allows (please check with decoder instructions: for example Bachmann 36-553 and 36-554 decoders will allow this) whilst other locomotives are on the track.

	Main track	Service track
Short address to another short address with decoder allowing Address (CV 1) to be programmed on Main Track	YES	YES
Short address with decoder not allowing Address (CV 1) to be programmed on Main Track	NO	YES
Long address using any decoder	NO	YES

If in doubt about the decoder specification, use the SERVICE TRACK to write the address.

The screen shows



I. Changing the locomotive address

The locomotive address can be set in either of two ways

- Service Track - all addresses 0001 to 9999
- Main Track - short addresses 1 to 127, only if allowed by the decoder

Using Main Track to change a short address to another short address

```
[MENU] -- scroll to      PROGRAM                      [ACCEPT]
                         -- scroll to      WRITE ADDR 0003
                                              ON MAINTRACK                [ACCEPT]

Screen shows                      CHANGE ADDR LOC
                                              WRITE ADDR 3
```

[BKSP] to delete existing address

Use alphanumeric keys or joystick to enter new address up to 127

*CHANGE ADDR 0003
WRITE ADDR 68*

Press [PROG] to write the new address

Both decoder and roster database are updated.

Using Service Track

[MENU] -- scroll to *PROGRAM* [ACCEPT]

 -- scroll to *WRITE ADDR 0003*
 ON SERVICETRACK [ACCEPT]

Screen shows

*WRITE ADDR LOC
WRITE ADDR 3*

[BKSP] to delete existing address

Use alphanumeric keys or joystick to enter new address of up to 4 digits

*CHANGE ADDR 0003
WRITE ADDR 4468*

Press [PROG] to write the new address

Both decoder and roster database are updated.

2. Changing the locomotive name

Each locomotive in the roster can be given a name of up to 16 characters, which could be its actual running number if longer than 4 digits. Choose any combination of letters and numbers using the alphanumeric lettering by each function key to enter the name.

[MENU] *EDIT NAME
LOCOMOTIVE 3*

[ACCEPT] *SET NAME
LOCOMOTIVE 3*

[BKSP] to delete 'LOCOMOTIVE 3'

Use alphanumeric keys or joystick to enter new name

MALLARD

[ACCEPT]

3. Changing the locomotive icon

Each entry in the roster can be given an indicative icon for the type of locomotive, or none.

[MENU] scroll to

*EDIT SYMBOL 4468
MALLARD*

[ACCEPT] *SET SYMBOL*

Scroll through the icons for DIESEL, STEAM, ELECTRIC or none

Choose STEAM

[ACCEPT]

4. Changing locomotive decoder speed steps

Most decoders operate on 28 or 128 speed steps. Consult your decoder instructions for information.

[MENU] scroll to

*EDIT SPEED 4468
MALLARD*

[ACCEPT] *SET SPEEDSTEPS*

Scroll *14 / 28 / 128 SPEEDSTEPS*

Choose *128*

[ACCEPT]

5. Changing the function setting

The control of each function on the decoder locomotive can be set to latch or trigger

Latch – once pressed the function output is activated until the key is pressed again to turn off

Trigger – the function is only activated for the duration of the press

Example: The headlights of a locomotive would have a latch setting so that they are left on until turned off again.



A coupling sound would have a trigger setting so that it can be played when required with a key press.

[MENU] *EDIT FXMODE*
 LOCOMOTIVE 4468

[ACCEPT] *SET FUNCTIONS*
 LATCHING

Use the function keys to select the function outputs of the decoder that are to latch. When the indicator shows on the screen the function is set to latch.

[ACCEPT]

The Screen now shows

LOC 4468 1/128
MALLARD

6. Deleting a locomotive

The roster entry can be deleted when no longer required. The currently controlled locomotive cannot be deleted unless it has a speed of 0.

How to manage consists

'Consist' is a term used to describe more than one locomotive or railcar each with its own decoder address being run at the same time as a single entity. 'Double header' or 'multiple unit' might also be used, but for simplicity the term 'consist' will be used here.

I. To add current loco to a consist:

NOTE a locomotive in a consist may have to run 'backwards' when the consist is running forwards – for example a pair of diesel locos with their cabs outwards. Use [DIRECTION] to set one of the pair in the reverse direction before putting in the consist.

Press [CONSIST]

ADD TO CONSIST
CONSIST ID 0 - choose a consist number in range 1 to 127

A consist cannot have the same number as a locomotive already in the roster

[CANCEL] to cancel [ACCEPT] to accept

CONSIST TYPE
Scroll to choose *UNIVERSAL* or *ADVANCED*

Universal Consists are handled by the Dynamis unit
Advanced Consists are a decoder feature – check that the decoder you are using has CV19 to allow this feature.

The consist indicator will now be showing against this locomotive

Each consist has its own place in the roster.

UNI *0001* indicates consist 001 is universal
ADV *0002* indicates consist 002 is advanced

[ACCEPT]

Each consist can be given a name

eg *PAIR OF 205* or *UP DASH 85* or *TWO BR 2185*

The consist can be controlled by:

Either consist address
or any of the individual locomotive addresses

Locomotive functions are controlled from the locomotive address.

2. Removing a loco from a consist

Scroll through the roster to the locomotive.

Press [CONSIST]. The locomotive is removed and the consist indicator no longer shows.

3. Deleting a consist

Once empty, a consist record can be deleted

How to operate turnouts and accessories

Press [MODE] to move the Handset into accessory mode

Screen shows *ACC ADD1 :01/1:*

This indicates accessory address 1 which is accessory decoder 1, output 1, assuming standard 4-output units

Scroll to using joystick, or enter an address with the numeric keys

ACC A067 :17/3

Accessory address 67 accessory decoder 17, is output 3

Addresses up to 100 (25 decoders) can be supported

Change direction by pressing [DIVERGE] or [STRAIGHT]

Creating accessory hotkey

A 'hotkey' shortcut from the numeric keypad can be set. The actual address of any particular accessory can be assigned to any of the 10 hotkeys available. By default, the hotkeys are accessory addresses 1 to 10. For example, the 10 most important turnouts on the layout can be given the shortcut.

In accessory mode SCROLL to the accessory address to be given an hotkey

[MENU] *EDIT HOTKEY ADDRESS* [ACCEPT]

SET HOTKEY

HOTKEY 0 OF ADDRESS

Enter the hotkey to be given to this accessory address [SELECT]

Using an accessory hotkey

Press [SHIFT] when in accessory mode.

Keys [F1] to [F10] control the 10 accessories given a hotkey shortcut.

Change direction by pressing [DIVERGE] or [STRAIGHT]

Programming an accessory decoder

Please refer to the instructions accompanying the E-Z Command Dynamis accessory decoder (item number 36-561) or E-Z Track digital turnout or www.dynamisdcc.com for more information.

How to program locomotive decoder CVs

CVs - 'Configuration variables' - are storage slots within the decoder which hold values to control its performance. Different decoders have a differing selection of CVs according to their specification. They control many different aspects of the decoders performance: eg maximum or minimum speed, how the headlights operate or whether the decoder operates on a DC supply. Refer to the instruction sheets that came with your decoder or locomotive for details of the features that are on your particular locomotive's decoder.

Dynamis has the capability of programming in one of two methods:

'Operations Mode' (also called 'Main track programming') - other locomotives can be left on the track as the programming instruction is sent to the particular decoder address.

'Service Mode' makes the entire layout a service track. All decoders present on the layout will receive the programming instruction. Other locomotives should be

removed from the track if using this method, or the locomotive programmed on an isolated Service Track. Decoders that do not accept Operations Mode programming should be programmed on a Service Track. Service mode also allows decoder CV values to be read: this is possible using the Dynamis ProBox.

Service Mode can be any of the following according to the requirements of the decoder:

```

Direct mode   'CV'
Paged mode   'PM'
Register mode 'RM'
Each with or without programming track power down
    
```

Most modern decoders work with Direct mode programming. Dynamis allows any or all of these methods to be set for a single programming session: adding modes adds to the time taken to program. Select the programming methods required using the System menu (see page 18).

Setting of locomotive decoder addresses is covered in **'How to configure the locomotive roster' on page 10**.

Some CVs are common to all decoders, eg CV 2 start speed or CV 29 configuration. Others are specific to the decoder. The Handset shows the description of common CVs.

EXAMPLE

To restrict the the maximum speed of a locomotive using Main Track programming

```

PROGRAM      4468
ON MAINTRACK
[ACCEPT]
POM CV 0
VAL 0  00000000
    
```

Set the value contained in CV5 to 20

```

POM CV 5      V HI
[<>VALUE]
VAL 20
[PROG]  the chosen value is written to the decoder
    
```

[CV<>] to continue programming another CV or
[CANCEL] to return to menu

How to configure using the System menu

Please refer to the full menu breakdown at page 24.

Joystick speed delay

Determines time before the speed repeat action is in effect.

Joystick speed repeat

Determines the rate of increase of speed on joystick movement.

Adjustment to these two settings changes the way the Handset actions speed increases in response to joystick movements

Joystick menu delay

Determines time before move to the next menu item when the joystick is held to left or right.

Joystick menu repeat

Determines speed of scroll through menus.

Adjustment to these two settings changes the way Handset moves through the menus in response to joystick movements

Backlight brightness

A higher value gives greater intensity of illumination.

Backlight duration

Sets the length of time before the screen backlighting illumination turns off.

A higher value gives a longer period of illumination.

A setting of 0 means the back light remains on constantly.

Edit stop mode

Set to either

POWER OFF to cut the power from the track to stop **all** trains running

or

ESTOP LOCOMOTIVE to bring the train currently under control to a stop.

Any other trains running will continue.

Holding down the STOP button for a few seconds cuts the power from the track to stop all trains.

It's recommended that the ESTOP LOCOMOTIVE setting is for advanced users only.

Edit track timeout

The Dynamis Handset and Command Station stay in contact. If the line of sight is lost the Command Station cuts track power. Use this setting to adjust the length of time before power is cut when contact is lost.

Edit Service Track Programing

Selects the modes used for Service Track programming.

Select a combination of the programming methods according to the requirements of the decoder being programmed.

Direct 'CV'
Paged mode 'PM'
Register mode 'RM'

With or without programming track power down.

èMost decoders will accept Direct Mode - leave at this setting unless a decoder has another requirement. Please consult you decoder instructions. More programming methods in use at one time increase the time to program.

Factory reset

Restores the default values, deleting all locomotives that are stored in the roster database.

Edit base ID

4 infra-red channels are available so that different layout in proximity can be controlled. The Command Station jumper and the handset to must operate on the same channel. Leave at 0 unless two or more Dynamis systems are being used in close proximity.

Edit base name

Allocates a name to the Command Station - used with the ProBox only

Edit remote name

Set a name for the Handset.

How to make the best of Dynamis on your layout

What kind of turnouts should be used?

Either 'live' or 'dead' frog turnouts can be used with Dynamis, to the layout builder's choice – dead frog turnouts are easier to install as the live frog turnout usually requires extra wiring. Details of the requirements included with the particular products.

For best results on a DCC layout, turnouts that *do not self isolate* are required. (Self isolating turnouts are those that enable a train to be parked in a siding on a DC layout when the turnout is closed against it.) Ideally the whole layout should be live so that trains stationary in sidings can have lights on and make sound.

If using Bachmann track products:

E-Z Track® can be used without modification because the turnouts do not self isolate.

Branchline track does self isolate. The turnouts can be modified simply by placing staples (larger, staple gun type) at the locations indicated although permanently wired connectors would be recommended for a permanent layout to ensure reliable operation.

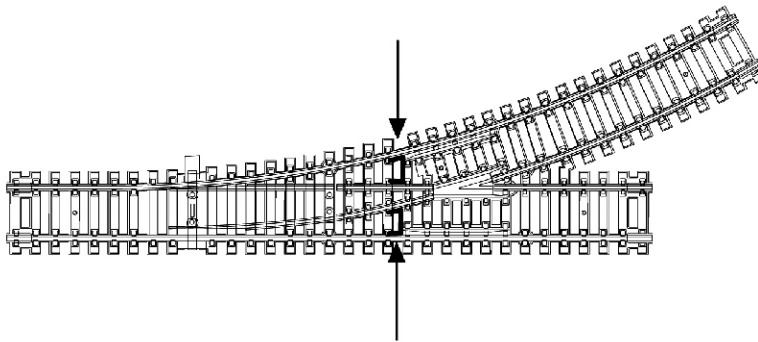

Connecting to an existing layout

When connecting Dynamis to an existing layout, existing controllers should be disconnected and all block switches (if any) turned on to put power to the whole layout.

High frequency track cleaners should be removed.

Reversing or station stop modules used on DC layouts cannot be used on a DCC and should be removed.

Do not use track power connectors that incorporate interference suppressors.

Service Mode programming and a Service Track

'Service Mode' programming makes the whole layout a Service Track and all decoders present on a layout will respond to the programming instructions. Unintended programming operations can be avoided by either:

- remove all other locomotives from the track whilst programming

Or:

create an isolated section of track to be a separate Service Track. Either disconnect your Dynamis Command station from the layout and connect to short length of track, or create separate block section on the main layout that can be separated from the remainder with a switch.

What is the rating of the track power?

The voltage is stabilised at $15.5v \pm 5\%$, with 2.3 amps of power.

How to use one Dynamis system in proximity with another

So that multiple Dynamis systems can be used in proximity, there are 4 infra-red signal channels available. The default setting of 0 should not be changed unless necessary to avoid a conflict with another Dynamis system in use in close by. Set the jumper plugs to the pins below the unit to use channels 1, 2 or 3 instead of 0, to match the channel set on the Handset. The pins are marked under the unit. Channel 0 uses no jumper plugs.

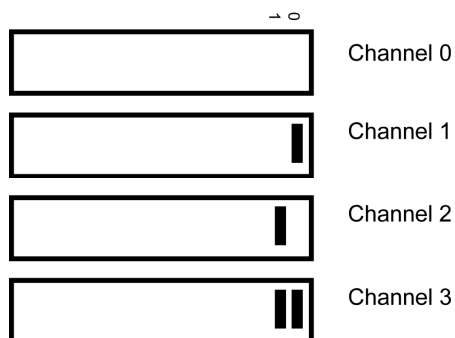

Safety and care of your

Dynamis

Use under adult supervision.

Only use the supplied power supply, taking care with the power lead. The appropriate mains pins for the local electricity supply requirement should be fitted by an adult: THE MAINS TRANSFORMER AND ITS PINS ARE NOT A TOY. Do not use if the cable becomes damaged. Contact a Bachmann Service Department should a replacement power supply be required.

Use only for the control of model trains.

Wipe only with a damp cloth - do not immerse in water or use any other cleaning agents.

For indoor use only - don't allow to become wet.

The handset is a precision item and should be treated with care - always use the lanyard to avoid dropping.

Batteries Use AAA / MN2400 / LR03 batteries
 Alkaline or NiCad or NiMH rechargeable batteries are suitable

 Insert into the handset with correct polarity

 Follow guidelines on the use and disposal of batteries
 Remove batteries from the handset when not in use to avoid
 damage from leakage

Fault finding

I can't run a train with my Dynamis system

Power supply not connected to Command Station - LEDs will illuminate on Command Station when power is applied. Connect power.

No connection to track - check connections.

Battery low indicator on Handset - replace batteries.

STOP or Short circuit indicator on Handset - check cause and press STOP to reset unit.

Handset out of range of Command Station- STOP will be illuminated - press to reset. The LED on the Command Station receiver flashed when signals are received.

Incorrect address of loco selected - check loco address and select locomotive with correct address.

Handset and Command Station not on same channels - check setting of Handset and set Command Station jumpers to the same channel.

Other Bachmann E-Z Command® DCC products that can be used with Dynamis

36-507 Dynamis ProBox

Upgrade your Dynamis system to operate with up to 4 wireless handsets, plus a programming track, a bus connector for wired throttles and devices, and more.

36-561 E-Z Command® accessory decoder for turnouts etc

36-520 E-Z Command® 5 Amp Power Booster

36-525 E-Z Command® Reversing Loop Module

Bachmann E-Z Command® decoders and DCC Onboard models are also available from your retailer.

Warranty information

Please refer to the enclosed sheet accompanying this user guide.

Technical support

Visit the Dynamis website www.dynamisdcc.com for technical information, updates and further information or contact us at one of these addresses.

Bachmann Industries, Inc
1400 East Erie Avenue
Philadelphia
PA 19124
USA
Tel: 1-800-356-3910

Niederlassung Deutschland
Am Umspannwerk 5
90518 Altdorf b. Nürnberg
Germany
Tel: + 49 9187 97220

Bachmann Europe PLC
Moat Way
Barwell
Leicestershire
LE9 8EY
United Kingdom
Tel: + 44 1455 841756

Dynamis is a registered trademark of
Bachmann Europe plc
E-Z Command and E-Z Track are
registered trademarks of Bachmann
Industries, Inc

Dynamis Menu Reference 1

Press [MENU] and scroll the menu with [SCROLL] or the joystick Press [CANCEL] to move back up the menu

	Option	Choices	Action
EDIT NAME	SET NAME Set 16 character name for locomotive or consist	KEY: up to 16 characters free text	✓ to accept ✗ to cancel
EDIT SYMBOL	SET SYMBOL Choose indicative symbol for locomotive or consist	SCROLL: Diesel / Steam / Electric / None	✓ to accept ✗ to cancel
EDIT SPEED	SET SPEEDSTEPS Sets speed steps decoder is operating at	SCROLL: 14 / 28 / 128	✓ to accept ✗ to cancel
EDIT FX MODE	SET FUNCTIONS TO LATCHING SELECT: F0 / F1 / F2 / F3 / F4 / F5 F6 / F7 / F8 / F9 / F10 / F11 / F12 / F13 F14 / F15 / F16 / F17 / F18 / F19 / F20		✓ to accept ✗ to cancel
DELETE LOCO or CONSIST	CONFIRM DELETE Deletes locomotive or consist record from database		✓ to accept ✗ to cancel
PROGRAM	WRITE ADDR ON MAINTRACK Writes a locomotive address using Programming on Main / Ops Mode WRITE ADDR ON SERVICETRACK Writes a locomotive address using Service Mode*		

Dynamis Menu Reference 2

-----	READ ADDR ON SERVICETRACK			
-----	Reads address using Service Track			
-----	(Function operates with DYNAMIS PRO box only)			
-----	PROGRAM ON SERVICE TRACK	POS CV number		
-----	VAL value			
-----	PROGRAM [CURRENT LOCO]ON MAINTRACK	POM CV number		
-----	VAL value			
-----	SYSTEM MENU			
-----	EDIT BASE ID	SET BASE ID	Enter number	✓ to accept
-----		Default = 0	Range 0-3	✗ to cancel
-----	EDIT REMOTE ID	SET REMOTE ID	Enter number	✓ to accept
-----		(Feature set with DYNAMIS PRO box only)		✗ to cancel
-----	SYSTEM INFO -----			
-----	EDIT BASE NAME	SET BASE NAME	Enter name	✓ to accept
-----				✗ to cancel
-----	BASE SERIAL NUMBER	U00000000		✓ to accept
-----				✗ to cancel
-----	BASE INFO_0	version number	Read Only	✗ to cancel
-----	EDIT REMOTE NAME	SET REMOTE NAME	Enter name	✓ to accept
-----		Default: Dynamis Remote		✗ to cancel

Dynamis Menu Reference 3

	version number	Read Only	
REMOTE INFO			✗ to cancel
EDIT JOYSTICK SPEED DELAY	SET JOYSTICK SPEED DELAY Default = 8 Range 0 - 63	Enter value	✓ to accept ✗ to cancel
EDIT JOYSTICK SPEED REPEAT	SET JOYSTICK SPEED REPEAT Default = 12 Range 0 - 63	Enter value	✓ to accept ✗ to cancel
EDIT JOYSTICK MENU DELAY	SET JOYSTICK MENU DELAY Default = 8 Range 0 - 63	Enter value	✓ to accept ✗ to cancel
EDIT JOYSTICK MENU REPEAT	SET JOYSTICK MENU REPEAT Default = 63 Range 0 - 63	Enter value	✓ to accept ✗ to cancel
EDIT BACKLIGHT BRIGHTNESS	SET BACKLIGHT BRIGHTNESS Default = 6 Range 0 - 8	Enter value	✓ to accept ✗ to cancel
EDIT BACKLIGHT DURATION	SET BACKLIGHT DURATION Default = 60 Range 0 - 255	Enter value	✓ to accept ✗ to cancel
EDIT STOPMODE	SET STOPMODE SCROLL: POWER OFF / ESTOP LOCOMOTIVE Sets action on use of STOP button Default = Power off		✓ to accept ✗ to cancel
EDIT SRV TRK PROG	SET SRV TRK PROG	SCROLL: CV Powerdown CV RM CV RM Powerdown CV PM CV PM powerdown CV PM RM	

Dynamis Menu Reference 4

-----	CV PM RM powerdown
-----	RM RM powerdown
-----	PM
-----	PM powerdown
-----	PM RM
-----	PM RM Powerdown
-----	CV
-----	Select Service Track programming methods to use
-----	Default = CV Powerdown
-----	✓ to accept
-----	✗ to cancel
-----	EDIT TRK TIMEOUT
-----	SET TRK TIMEOUT SCROLL: No timeout / 7.5 sec / 15 sec / 30 sec
-----	✓ to accept
-----	✗ to cancel
-----	Default = 30 sec
-----	FACTORY RESET
-----	ARE YOU SURE ?
-----	Reset the default values
-----	✓ to accept
-----	✗ to cancel



BACHMANN USA
1400 East Erie Avenue
Philadelphia,
PA 19124, USA
www.bachmanntrains.com



BACHMANN EUROPE PLC (UK)
Moat Way, Barwell
Leicestershire, LE9 8EY
United Kingdom
www.bachmann.co.uk



BACHMANN EUROPE PLC
Am Umspannwerk 5
90518 Altdorf bei Nürnberg
Germany
www.liliput.de



BACHMANN CHINA LTD.
Rm.1102, 595 Wu Ding Road,
Shanghai, China. P.C.200040
www.bachmannchina.com.cn

Visit the
Dynamis website
www.dynamisdcc.com

Text copyright © 2007 Bachmann Europe plc



MADE IN CHINA

16V

Input: 100V - 240V AC, 50/60 Hz.
Output: 16V DC 2.3 Amp power supply